

**GOODWE**



# **User Manual**

**Grid-Tied PV Inverter**

DNS Series  
(3.0-6.0kW) G3

V1.6-2023-12-25

**Trademarks**

**GOODWE** and other GOODWE trademarks are trademarks of GoodWe Technologies Co.,Ltd. All other trademarks or registered trademarks mentioned in this manual are owned by GoodWe Technologies Co.,Ltd.

**NOTICE**

The information in this user manual is subject to change due to product updates or other reasons. This guide cannot replace the product labels or the safety precautions in the user manual unless otherwise specified. All descriptions here are for guidance only.

# CONTENT

<b>1</b>	<b>About This Manual</b> .....	<b>1</b>
1.1	Applicable Model .....	1
1.2	Target Audience .....	1
1.3	Symbol Definition .....	2
1.4	Updates .....	2
<b>2</b>	<b>Safety Precaution</b> .....	<b>3</b>
2.1	General Safety .....	3
2.2	DC Side .....	3
2.3	AC Side .....	3
2.4	Inverter Installation .....	4
2.5	Personal Requirements .....	4
2.6	EU Declaration of Conformity .....	5
<b>3</b>	<b>Product Introduction</b> .....	<b>6</b>
3.1	Application Scenarios .....	6
3.2	Circuit Diagram .....	6
3.3	Supported Grid Types .....	6
3.4	Appearance .....	7
3.4.1	Parts .....	7
3.4.2	Dimensions .....	8
3.4.3	Indicators .....	8
3.4.3	Nameplate .....	9
<b>4</b>	<b>Check and Storage</b> .....	<b>10</b>
4.1	Check Before Receiving .....	10
4.2	Deliverables .....	10
4.3	Storage .....	11
<b>5</b>	<b>Installation</b> .....	<b>12</b>
5.1	Installation Requirements .....	12
5.2	Inverter Installation .....	15
5.2.1	Moving the Inverter .....	15
5.2.2	Installing the Inverter .....	15

<b>6</b>	<b>Electrical Connection .....</b>	<b>16</b>
6.1	Safety Precaution .....	16
6.2	Connecting the PE Cable .....	17
6.3	Connecting the PV Input Cable .....	17
6.4	Connecting the AC Output Cable .....	20
6.5	Communication .....	24
6.5.1	Communication Network Introduction .....	24
6.5.1	Connecting the Communication Cable (optional).....	25
6.5.3	Installing the Communication Module (optional).....	27
6.5.4	Connecting the USB-RS485 Cable.....	27
<b>7</b>	<b>Equipment Commissioning .....</b>	<b>28</b>
7.1	Check Before Power ON .....	28
7.2	Power On.....	28
<b>8</b>	<b>System Commissioning .....</b>	<b>29</b>
8.1	Indicators and Buttons .....	29
8.2	Setting Inverter Parameters via LCD .....	30
8.2.1	LCD Menu Introduction.....	31
8.2.2	Inverter Parameter Introduction .....	32
8.3	Upgrading the Firmware Via USB Flash Disk .....	33
8.4	Setting Inverter Parameters via SolarGo App .....	33
<b>9</b>	<b>Maintenance .....</b>	<b>34</b>
9.1	Power Off the Inverter.....	34
9.2	Removing the Inverter.....	34
9.3	Disposing of the Inverter .....	34
9.4	Troubleshooting .....	34
9.5	Routine Maintenance.....	41
<b>10</b>	<b>Technical Parameters .....</b>	<b>42</b>

# 1 About This Manual

This manual describes the product information, installation, electrical connection, commissioning, troubleshooting, and maintenance. Read through this manual before installing and operating the product. All the installers and users have to be familiar with the product features, functions, and safety precautions. This manual is subject to update without notice. For more product details and latest documents, visit <https://en.goodwe.com>.

## 1.1 Applicable Model

This manual applies to the listed inverters below (DNS G3 or Inverter for short):



Model	Nominal Output Power	Nominal Output Voltage
GW3000-DNS-30	3kW	220/230/240V
GW3600-DNS-30	3.6kW	
GW4200-DNS-30	4.2kW	
GW5000-DNS-30	5kW	
GW6000-DNS-30	6kW	
GW5000-DNS-B30	5kW	
GW6000-DNS-B30	6kW	
GW5000-DNS-EU30	5kW	

## 1.2 Target Audience

This manual applies to trained and knowledgeable technical professionals. The technical personnel has to be familiar with the product, local standards, and electric systems.

### 1.3 Symbol Definition

Different levels of warning messages in this manual are defined as follows:

 <b>DANGER</b>
Indicates a high-level hazard that, if not avoided, will result in death or serious injury.
 <b>WARNING</b>
Indicates a medium-level hazard that, if not avoided, could result in death or serious injury.
 <b>CAUTION</b>
Indicates a low-level hazard that, if not avoided, could result in minor or moderate injury.
<b>NOTICE</b>
Highlight and supplement the texts. Or some skills and methods to solve product-related problems to save time.

## 2 Safety Precaution

### Notice

The inverters are designed and tested strictly complies with related safety rules. Read and follow all the safety instructions and cautions before any operations. Improper operation might cause personal injury or property damage as the inverters are electrical equipment.

### 2.1 General Safety

#### Notice

- The information in this user manual is subject to change due to product updates or other reasons. This guide cannot replace the product labels or the safety precautions in the user manual unless otherwise specified. All descriptions here are for guidance only.
- Before installations, read through the quick installation guide. For additional information, please see the user manual.
- All installations should be performed by trained and knowledgeable technicians who are familiar with local standards and safety regulations.
- Use insulating tools and wear personal protective equipment when operating the equipment to ensure personal safety. Wear anti-static gloves, cloths, and wrist strips when touching electron devices to protect the inverter from damage.
- Strictly follow the installation, operation, and configuration instructions in this manual. The manufacturer shall not be liable for equipment damage or personal injury if you do not follow the instructions. For more warranty details, please visit <https://en.goodwe.com/warranty>.

### 2.2 DC Side

#### DANGER

Connect the DC cables using the delivered PV connectors. The manufacturer shall not be liable for the equipment damage if other connectors or terminals are used.

#### WARNING

- Ensure the component frames and the bracket system are securely grounded.
- Ensure the DC cables are connected tightly, securely and correctly.
- Measure the DC cable using the multimeter to avoid reverse polarity connection. Also, the voltage should be under the permissible range.

### 2.3 AC Side









#### WARNING

- The voltage and frequency at the connection point meet the inverter grid connection requirements
- Additional protective devices like circuit breakers or fuses are recommended on the AC side. Specification of the protective device should be at least 1.25 times the rated AC output rated current.
- Make sure that all the groundings are tightly connected.
- You are recommended to use copper cables as AC output cables. Contact the manufacturer if you want to use other cables.

## 2.4 Inverter Installation

### ⚠ DANGER

- Do not apply mechanical load to the terminals, otherwise the terminals can be damaged.
- All labels and warning marks should be visible after the installation. Do not scrawl, damage, or cover any label on the device.
- Inverters should not be installed in multiple phase combination.
- Warning labels on the inverter are as follows.

	DANGER High voltage hazard. Disconnect all incoming power and turn off the product before working on it.		Delayed discharge. Wait 5 minutes after power off until the components are completely discharged.
	Read through the user manual before working on this device.		Potential risks exist. Wear proper PPE before any operations.
	High-temperature hazard. Do not touch the product under operation to avoid being burnt.		Grounding point.
	CE Mark		Do not dispose of the inverter as household waste. Discard the product in compliance with local laws and regulations, or send it back to the manufacturer.

## 2.5 Personal Requirements

### NOTICE

- Personnel who install or maintain the equipment must be strictly trained, learn about safety precautions and correct operations.
- Only qualified professionals or trained personnel are allowed to install, operate, maintain, and replace the equipment or parts.



## 2.6 EU Declaration of Conformity

GoodWe Technologies Co., Ltd. hereby declares that the inverter with wireless communication modules sold in the European market meets the requirements of the following directives:

- Radio Equipment Directive 2014/53/EU (RED)
- Restrictions of Hazardous Substances Directive 2011/65/EU and (EU) 2015/863 (RoHS)
- Waste Electrical and Electronic Equipment 2012/19/EU
- Registration, Evaluation, Authorization and Restriction of Chemicals (EC) No 1907/2006 (REACH)

GoodWe Technologies Co., Ltd. hereby declares that the inverter without wireless communication modules sold in the European market meets the requirements of the following directives:

- Electromagnetic compatibility Directive 2014/30/EU (EMC)
- Electrical Apparatus Low Voltage Directive 2014/35/EU (LVD)
- Restrictions of Hazardous Substances Directive 2011/65/EU and (EU) 2015/863 (RoHS)
- Waste Electrical and Electronic Equipment 2012/19/EU
- Registration, Evaluation, Authorization and Restriction of Chemicals (EC) No 1907/2006 (REACH)

You can download the EU Declaration of Conformity on <https://en.goodwe.com>.

### 3 Product Introduction

#### 3.1 Application Scenarios

The DNS G3 inverter is a single-phase PV string grid-tied inverter. The inverter converts the DC power generated by the PV module into AC power and feeds it into the utility grid. The intended use of the inverter is as follows:

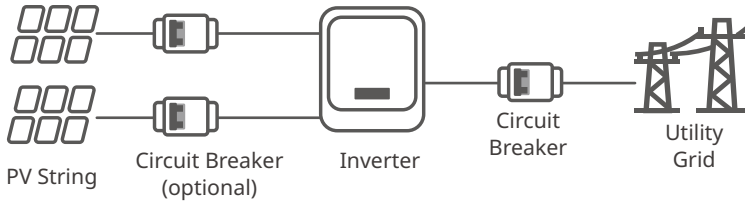

#### 3.2 Circuit Diagram

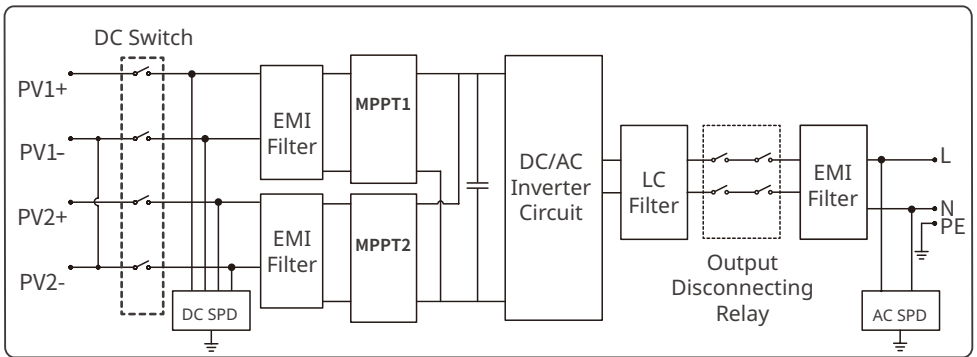

#### 3.3 Supported Grid Types

For the grid type with neutral wire, the N to ground voltage must be less than 10V.

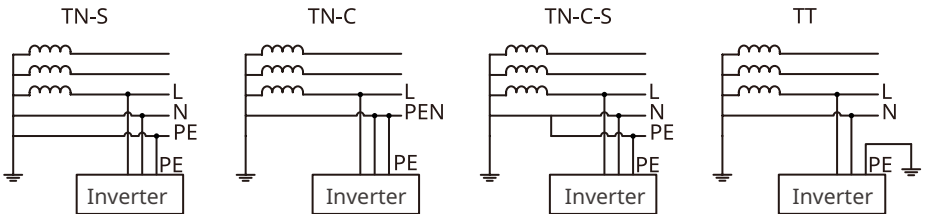

## 3.4 Appearance

### 3.4.1 Parts

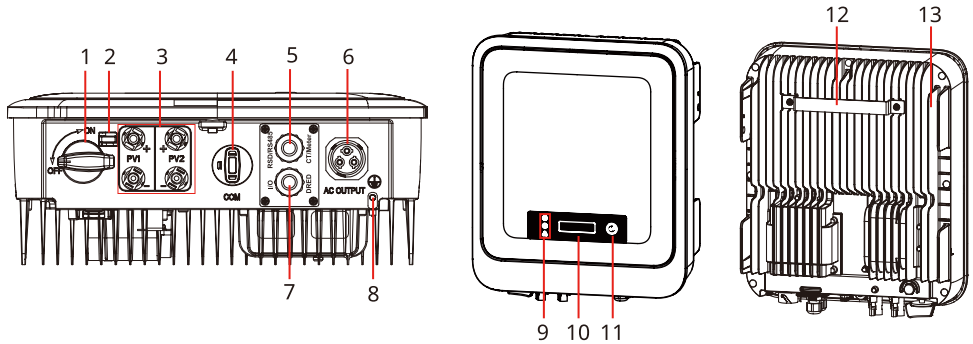





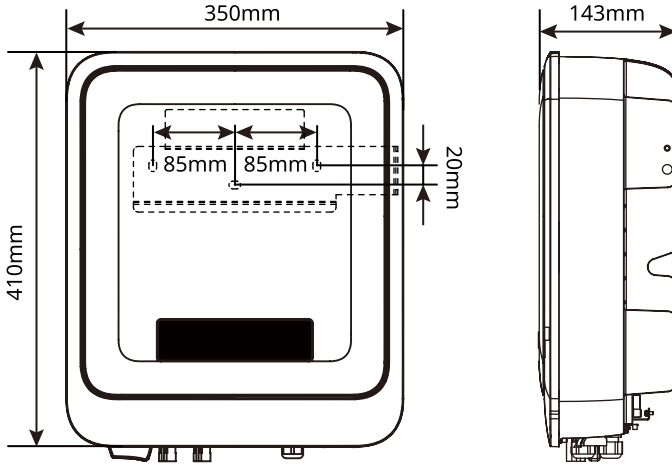







No.	Parts	Description
1	DC Switch	Start or stop DC input.
2	DC Switch Lock	Only for Australia. Turn the DC switch to OFF and lock it to avoid electric shock when you have to work on the inverter.
3	PV Input Terminal	Used to connect the PV module DC input cables.
4	COM Port for communication module, USB-RS485 cable or USB.	<ul style="list-style-type: none"> <li>Connect a communication module like Bluetooth, WiFi/LAN, WiFi, GPRS, 4G, etc. The module type may differ depending on actual needs.</li> <li>Connect the USB-RS485 cable in Brazil.</li> <li>Update the software version of the inverter using a USB flash driver.</li> </ul>
5	COM Port for RS485, remote shutdown, meter, or CT.	Used to connect the RS485, meter, CT, or remote shutdown communication cable.
6	AC Terminal	Used to connect the AC output cable, which connects the inverter and the utility grid.
7	COM Port for DRED or dry contact.	Reserved port. Used to connect the DRED cable or dry contact cable.
8	Grounding Point	Used to connect the PE cable.
9	Indicator	Indicates working state of the inverter.
10	LCD (optional)	Optional. Used to check the parameters of the inverter.
11	Button (optional)	Optional. Used to select menus displayed on the screen.
12	Mounting Plate	Used to install the inverter.
13	Heat sink	Used to cool the inverter.

### 3.4.2 Dimensions





















### 3.4.3 Indicators

#### With LCD

Indicator	Status	Description
 Power		ON = Wi-Fi IS CONNECTED/ACTIVE
		BLINK 1 = Wi-Fi SYSTEM IS RESETTING
		BLINK 2 = NOT CONNECTED TO THE ROUTER
		BLINK 4 = Wi-Fi SERVER PROBLEM
		BLINK = RS485 IS CONNECTED
		OFF = Wi-Fi IS NOT ACTIVE
 Operating		ON = THE INVERTER IS FEEDING POWER
		OFF = THE INVERTER IS NOT FEEDING POWER AT THE MOMENT
 Faulty		ON = A FAULT HAS OCCURRED
		OFF = NO FAULT

#### Without LCD

Indicators	Status	Description
 Power		ON= EQUIPMENT POWER ON
		OFF= EQUIPMENT POWER OFF
 Operating		ON= THE INVERTER IS FEEDING POWER
		OFF= THE INVERTER IS NOT FEEDING POWER
		SINGLE SLOW FLASH= SELF CHECK BEFORE CONNECTING TO THE GRID
		SINGLE FLASH = CONNECTING TO THE GRID

Indicators	Status	Description
 SEMS		ON= WIRELESS IS CONNECTED/ACTIVE
		BLINK 1 = WIRELESS SYSTEM IS RESETTING
		BLINK 2 = WIRELESS ROUTER PROBLEM
		BLINK 4 = WIRELESS SERVER PROBLEM
		BLINK = RS485 IS CONNECTED
		OFF= WIRELESS IS NOT ACTIVE
 Faulty		ON= A FAULT HAS OCCURRED
		OFF= NO FAULT

### 3.4.3 Nameplate





The nameplate is for reference only.





GOODWE

Product: Grid-Tied PV Inverter  
 Model : \*\*\*\*\*\_\*\*\*\_\*\*

PV Input	UDCmax: **** Vd.c.
	UMPP: **...** Vd.c.
	IdC,max: ** Ad.c.
	ISC PV: ** Ad.c.
Output	UAC,r: *** Va.c.
	fAC, r: ** Hz
	PAC,r: ** kW
	IAC,max: ** Aa.c.
	Sn: ** kVA
	Smax: ** kVA

PF: -~\*\*cap...\*\*ind  
 Toperating: ~\*\*~\*\* °C  
 Non-isolated, IP\*\*, protective Class I, OVC DCII/ACIII

S/N:

\*\*\*\*\* Co., Ltd.  
 E-mail: \*\*\*\*\*@\*\*\*\*.com  
 \*\*\*\*\*

S/N

GW trademark, product type, and product model

Technical parameters

Safety symbols and certification marks

Contact information and serial number

## 4 Check and Storage

### 4.1 Check Before Receiving

Check the following items before receiving the product.

1. Check the outer packing box for damage, such as holes, cracks, deformation, and other signs of equipment damage. Do not unpack the package and contact the supplier as soon as possible if any damage is found.
2. Check the inverter model. If the inverter model is not what you requested, do not unpack the product and contact the supplier.
3. Check the deliverables for correct model, complete contents, and intact appearance. Contact the supplier as soon as possible if any damage is found.

### 4.2 Deliverables

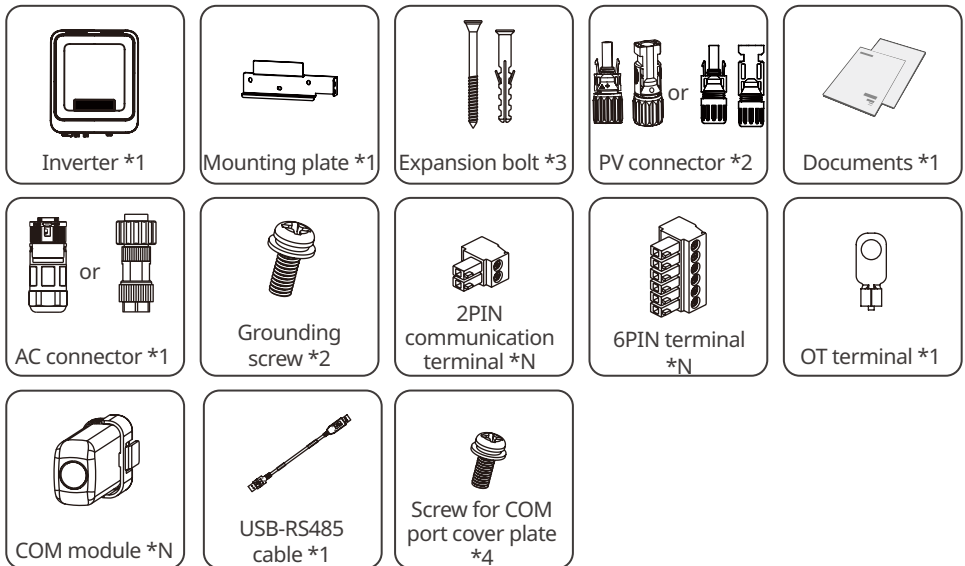

#### Notice

- The type and number of the 2PIN terminal and the 6PIN terminal are decided by the selected communication method.
- Communication module types: WiFi/LAN, WiFi, LAN, GPRS, Bluetooth, 4G, etc. The actual module delivered depends on the communication method of the selected inverter.
- USB-RS485 cable is only for Brazil.

## 4.3 Storage

If the equipment is not to be installed or used immediately, please ensure that the storage environment meets the following requirements:

1. Do not unpack the outer package or throw the desiccant away.
2. Store the equipment in a clean place. Make sure the temperature and humidity are appropriate and no condensation.
3. The height and direction of the stacking inverters should follow the instructions on the packing box.
4. The inverters must be stacked with caution to prevent them from falling.
5. If the inverter has been long term stored, it should be checked by professionals before being put into use.

## 5 Installation

### 5.1 Installation Requirements

#### Installation Environment Requirements

1. Do not install the equipment in a place near flammable, explosive, or corrosive materials.
2. Install the equipment on a surface that is solid enough to bear the inverter weight.
3. Install the equipment in a well-ventilated place to ensure good dissipation. Also, the installation space should be large enough for operations.
4. The equipment with a high ingress protection rating can be installed indoors or outdoors. The temperature and humidity at the installation site should be within the appropriate range.
5. Install the equipment in a sheltered place to avoid direct sunlight, rain, and snow. Build a sunshade if it is needed.
6. Do not install the equipment in a place that is easy to touch, especially within children's reach. High temperature exists when the equipment is working. Do not touch the surface to avoid burning.
7. Install the equipment at a height that is convenient for operation and maintenance, electrical connections, and checking indicators and labels.
8. Install the inverter away from high magnetic field to avoid electromagnetic interference. If there is any radio or wireless communication equipment below 30MHz near the inverter, you have to:
  - Install the inverter at least 30m far away from the wireless equipment.
  - Add a low pass EMI filter or a multi winding ferrite core to the DC input cable or AC output cable of the inverter.

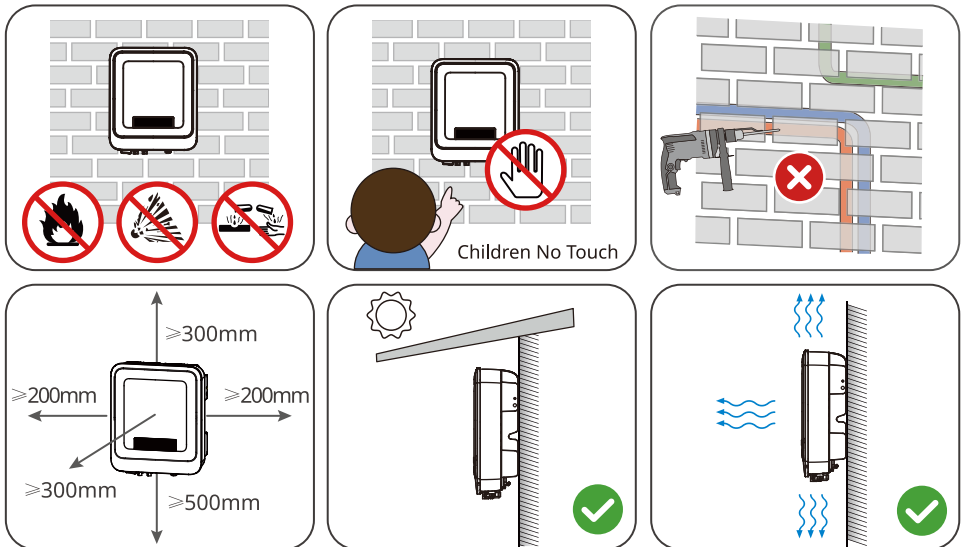



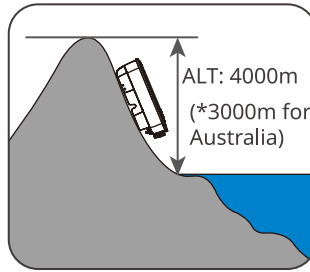
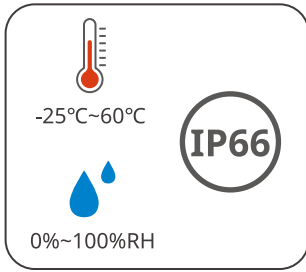

### Mounting Support Requirements

- The mounting support shall be nonflammable and fireproof.
- Make sure that the support surface is solid enough to bear the product weight load.
- Do not install the product on the support with poor sound insulation to avoid the noise generated by the working product, which may annoy the residents nearby.

### Installation Angle Requirements

- Install the inverter vertically or at a maximum back tilt of 15 degrees.
- Do not install the inverter upside down, forward tilt, back forward tilt, or horizontally.

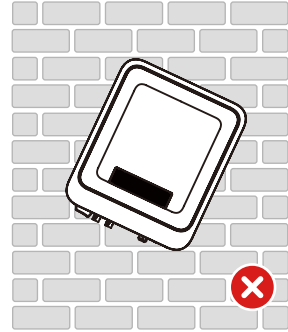
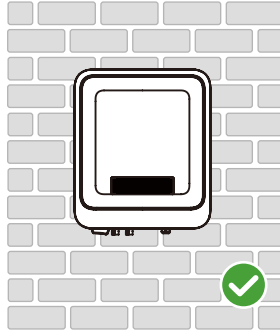
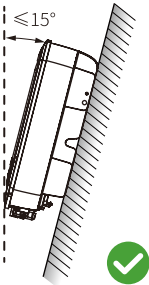

### Installation Tool Requirements

The following tools are recommended when installing the equipment. Use other auxiliary tools on site if necessary.

				
Goggles	Safety shoes	Safety gloves	Dust mask	DC terminal crimping tool
				
Diagonal pliers	Wire stripper	Hammer drill	Heat gun	DC wiring wrench
				
Marker	Level	Heat shrink tube	Rubber hammer	Vacuum cleaner
				
Multimeter	Cable tie	Torque wrench		

## 5.2 Inverter Installation

### 5.2.1 Moving the Inverter

#### CAUTION

Move the inverter to the site before installation. Follow the instructions below to avoid personal injury or equipment damage.

1. Consider the weight of the equipment before moving it. Assign enough personnel to move the equipment to avoid personal injury.
2. Wear safety gloves to avoid personal injury.
3. Keep balance to avoid falling down when moving the equipment.

### 5.2.2 Installing the Inverter

#### NOTICE

- Avoid the water pipes and cables buried in the wall when drilling holes.
- Wear goggles and a dust mask to prevent the dust from being inhaled or contacting eyes when drilling holes.
- The DC switch lock is prepared by the customer.

**Step 1** Put the mounting plate on the wall or the support horizontally and mark positions for drilling holes.

**Step 2** Drill holes to a depth of 80mm using the hammer drill. The diameter of the drill bit should be 8mm.

**Step 3** Secure the mounting plate using the expansion bolts.

**Step 4 (Only for Australia.)** Install the DC switch lock.

**Step 5** Install the inverter on the mounting plate.

**Step 6** Install the anti-theft lock.

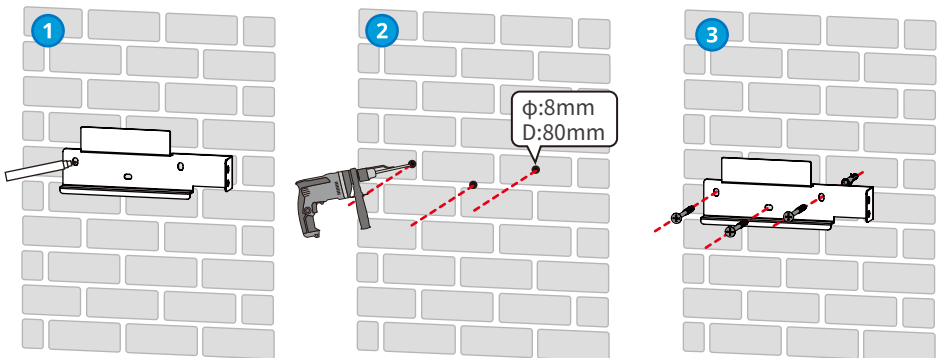

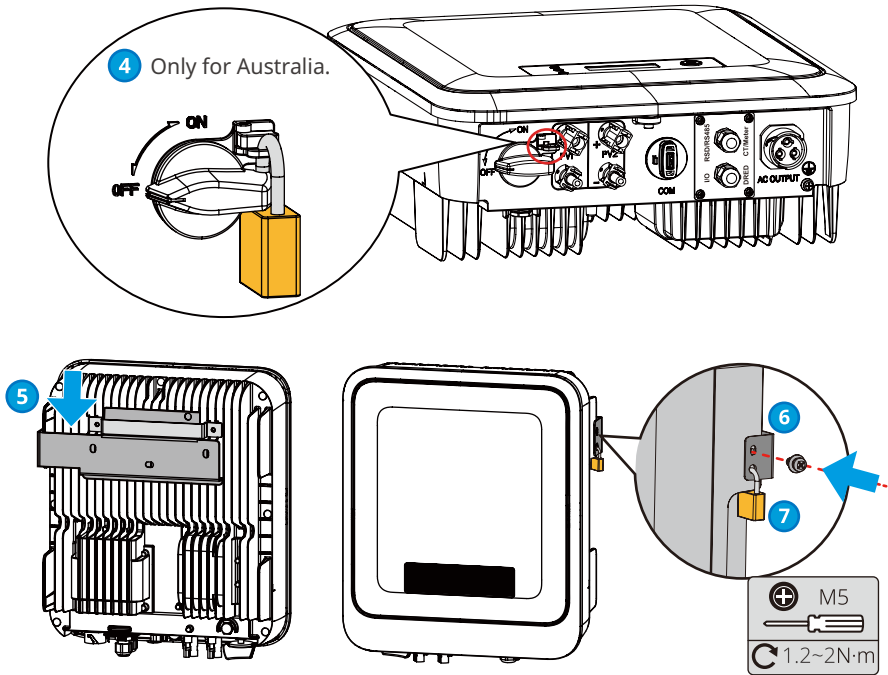

## 6 Electrical Connection

### 6.1 Safety Precaution

#### **! DANGER**

- Disconnect the DC switch and the AC output switch of the inverter to power off the inverter before any electrical connections. Do not work with power on. Otherwise, an electric shock may occur.
- Perform electrical connections in compliance with local laws and regulations. Including operations, cables, and component specifications.
- If the cable bears too much tension, the connection may be poor. Reserve a certain length of the cable before connecting it to the inverter cable port.

#### **NOTICE**

- Wear personal protective equipment like safety shoes, safety gloves, and insulating gloves during electrical connections.
- All electrical connections should be performed by qualified professionals.
- Cable colors in this document are for reference only. The cable specifications shall meet local laws and regulations.

## 6.2 Connecting the PE Cable

### WARNING

- The PE cable connected to the enclosure of the inverter cannot replace the PE cable connected to the AC output port. Make sure that both of the two PE cables are securely connected.
- Make sure that all the grounding points on the enclosures are equipotential connected when there are multiple inverters.
- To improve the corrosion resistance of the terminal, you are recommended to apply silica gel or paint on the ground terminal after installing the PE cable.
- The PE cable is prepared by the customer. Recommended specifications:
  - Type: single-core outdoor copper cable
  - Conductor cross-sectional area: 4mm<sup>2</sup>

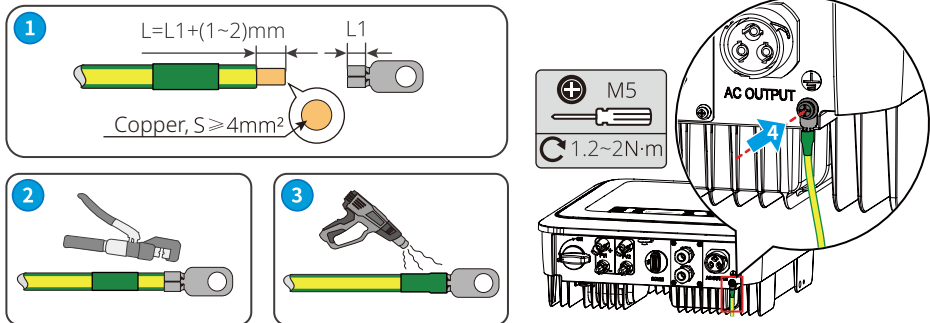

## 6.3 Connecting the PV Input Cable

### DANGER

Confirm the following information before connecting the PV string to the inverter. Otherwise, the inverter may be damaged permanently or even cause fire and cause personal and property losses.

1. Make sure that the max short circuit current and the max input voltage per MPPT are within the permissible range.
2. Make sure that the positive pole of the PV string connects to the PV+ of the inverter. And the negative pole of the PV string connects to the PV- of the inverter.

### WARNING

- Mixing PV modules of different brands or models in the same MPPT or connecting PV modules with different directions or inclination angles in the same PV string may not necessarily damage the inverter, but may lead to a decrease in the system performance.
- The maximum open-circuit voltage of each PV string cannot exceed 600V.
- It is recommended that the voltage difference between MPPTs shall be less than 200V.
- It is recommended that the sum of the  $I_{mp}$  of the PV strings connected to each MPPT shall not exceed the Max. Input Current per MPPT of the inverter.
- When there are multiple PV strings, it is recommended to maximize the connections of MPPTs.

**WARNING**

- Connect the DC cables using the delivered PV connectors. The manufacturer shall not be liable for the damage if other connectors are used.
- The PV strings cannot be grounded. Ensure the minimum isolation resistance of the PV string to the ground meets the minimum isolation resistance requirements before connecting the PV string to the inverter.
- The DC input cable is prepared by the customer. Recommended specifications:
  - Type: the outdoor photovoltaic cable that meets the maximum input voltage of the inverter.
  - Conductor cross-sectional area: 2.5~4mm<sup>2</sup> (Devalan) or 4~6mm<sup>2</sup> (MC4).

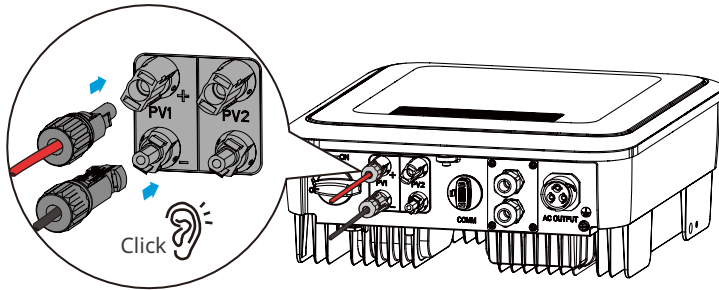

**NOTICE**

Seal the PV input terminals using waterproof covers when they are not to be used. Otherwise, the ingress protection rating will be influenced.

**Connecting the DC Input Cable**

- Step 1** Prepare DC cables.
- Step 2** Crimp the crimp contacts.
- Step 3** Disassemble the PV connectors.
- Step 4** Make the DC cable and detect the DC input voltage.
- Step 5** Plug the PV connectors into the PV terminals.

**Devalan PV connector**

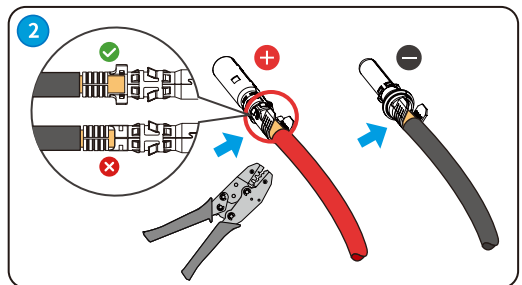
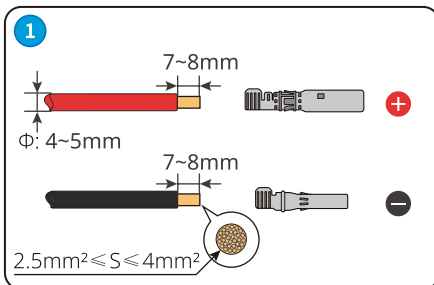

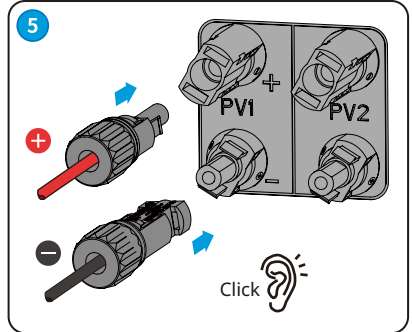
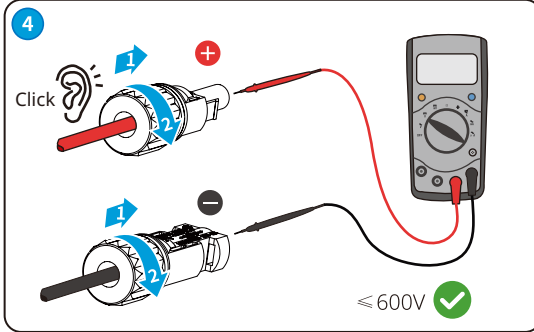
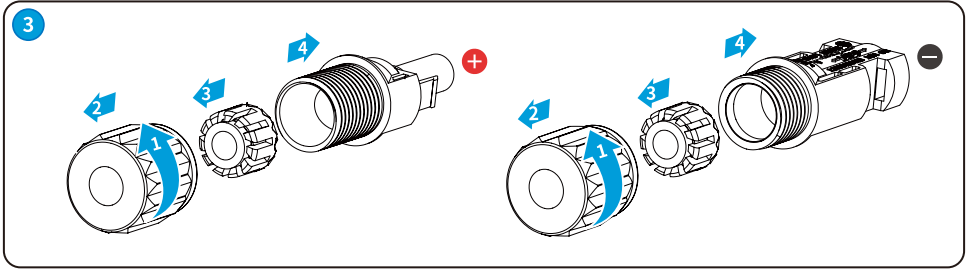

**Stäubli MC4 PV connector**

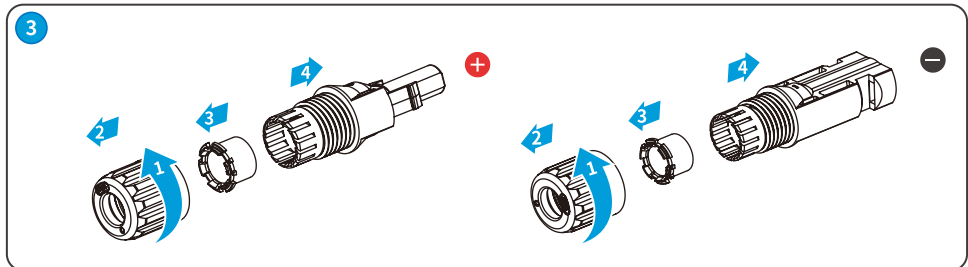
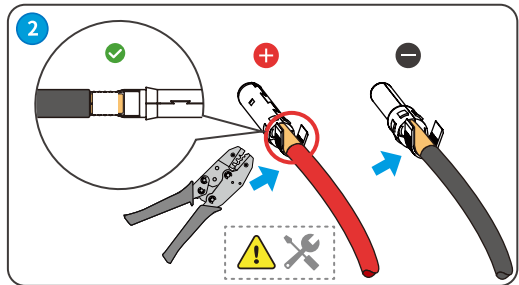
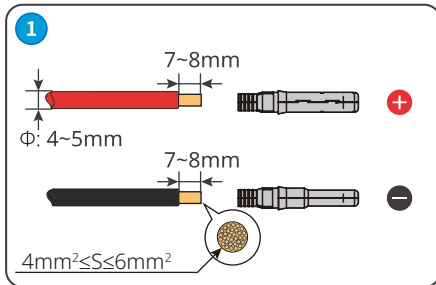

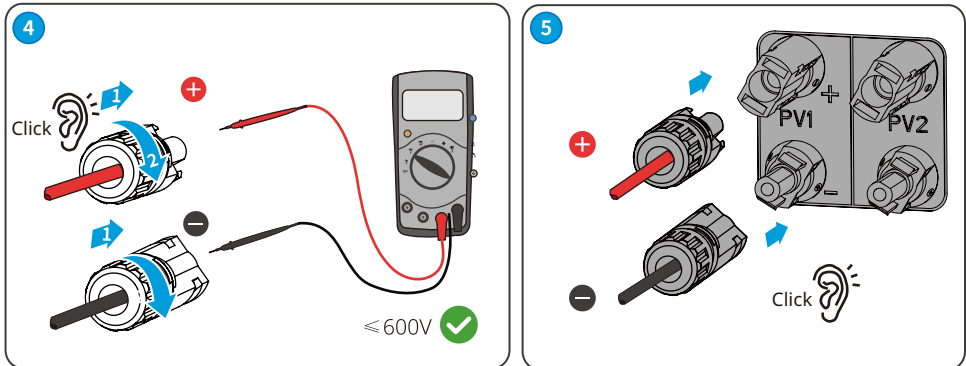

## 6.4 Connecting the AC Output Cable

### ⚠ WARNING

- Do not connect loads between the inverter and the AC switch directly connected to the inverter.
- The Residual Current Monitoring Unit (RCMU) is integrated into the inverter. The inverter will disconnect the utility grid rapidly once it detects any leak current over the permissible range.

An AC circuit breaker shall be installed on the AC side to make sure that the inverter can safely disconnect the grid when an exception happens. Select the appropriate AC circuit breaker in compliance with local laws and regulations. Recommended AC circuit breakers:

Inverter model	AC circuit breaker
GW3000-DNS-30	25A
GW3600-DNS-30	25A
GW4200-DNS-30	32A
GW5000-DNS-30	32A
GW6000-DNS-30	40A
GW5000-DNS-B30	32A
GW6000-DNS-B30	40A
GW5000-DNS-EU30	32A



Select and Install RCD depending on local laws and regulations. Type A RCDs (Residual Current Monitoring Device) can be connected to the outside of the inverter for protection when the DC component of the leakage current exceeds the limit value. The following RCDs are for reference:

Model	RCD specifications
GW3000-DNS-30	300mA
GW3600-DNS-30	
GW4200-DNS-30	
GW5000-DNS-30	
GW6000-DNS-30	
GW5000-DNS-B30	
GW6000-DNS-B30	
GW5000-DNS-EU30	

#### NOTICE

Install one AC circuit breaker for each inverter. Multiple inverters cannot share one AC circuit breaker.



#### WARNING

- Pay attention to the silkscreens L, N, PE on the AC terminal. Connect the AC cables to the corresponding terminals. The inverter may be damaged if the cables are connected inappropriately.
- Make sure that the whole cable cores are inserted into the AC terminal holes. No part of the cable core can be exposed.
- Make sure that the cables are connected securely. Otherwise, the terminal may be too hot to damage the inverter when the inverter is working.

**Step 1** Make the AC output cable.

**Step 2** Disassemble the AC connector.

**Step 3** Insert the AC output cable into the AC connector.

**Step 4** Plug the AC connector into the inverter.

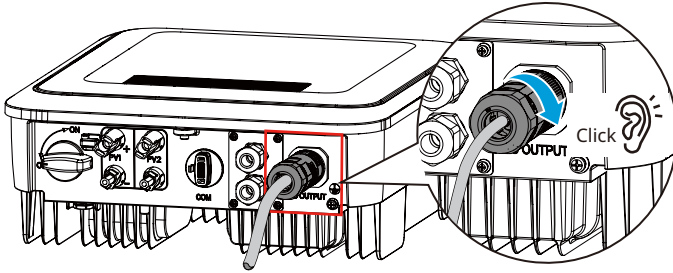

AC Connector-1

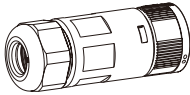

AC Connector-2

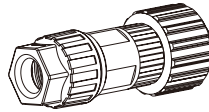

or

### AC Connector-1

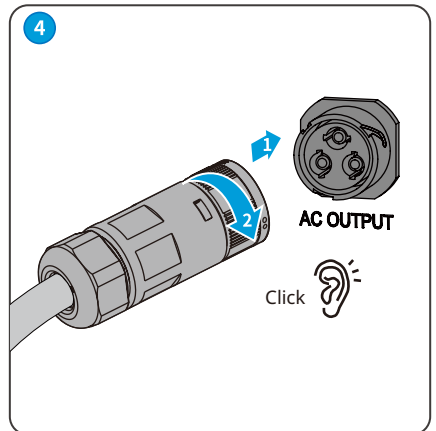
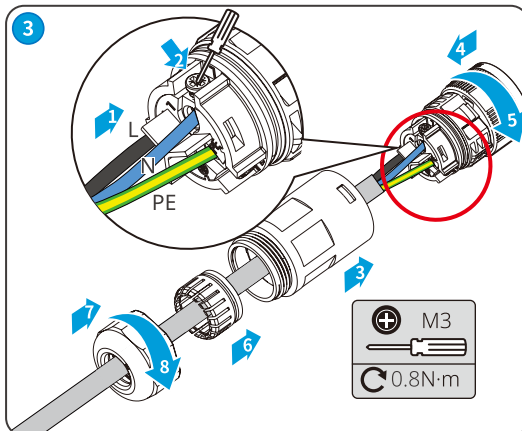
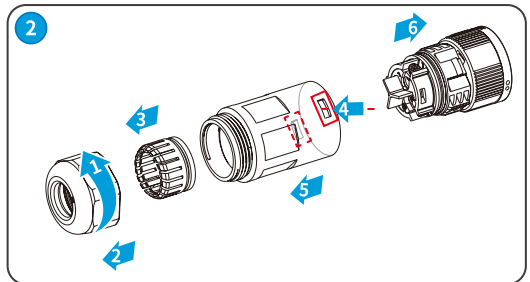
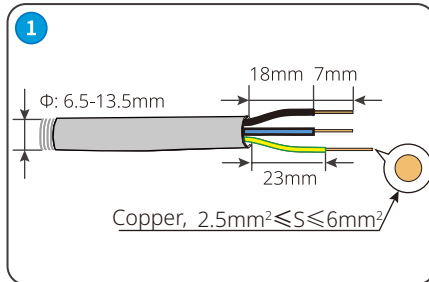

Disconnect AC terminal

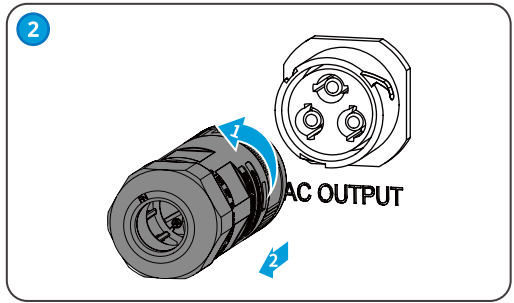
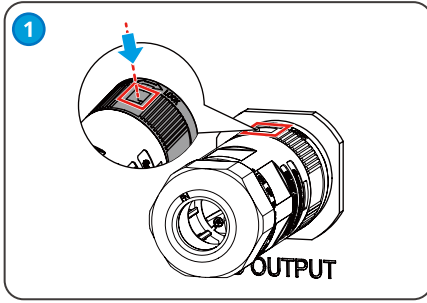

AC Connector-2

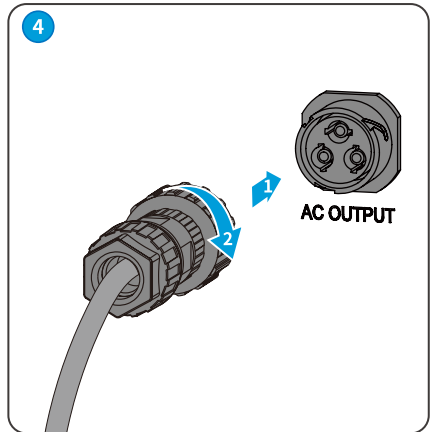
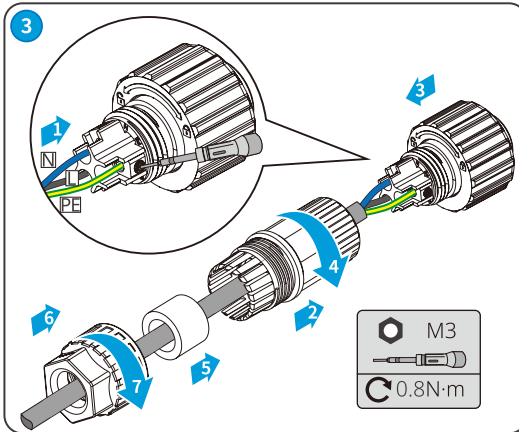
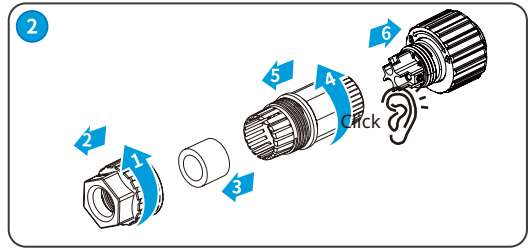
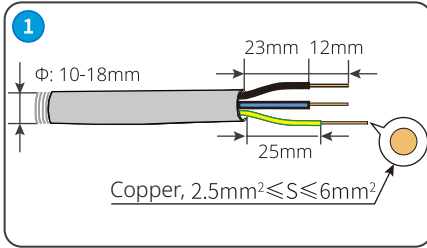

NOTICE

- Make sure that the cable is connected correctly and securely. Clear the debris after completing the connection.
- Seal the AC output terminal to ensure the ingress protection rating.

## 6.5 Communication

### 6.5.1 Communication Network Introduction

#### Power Limit Network

The PV station generates power for self-consumption, but the electric equipment cannot consume all the generated power. The inverter can monitor the on-grid electric data in real-time and adjust the output power via a smart meter to avoid the residual current feeding back to the utility grid.

GM1000

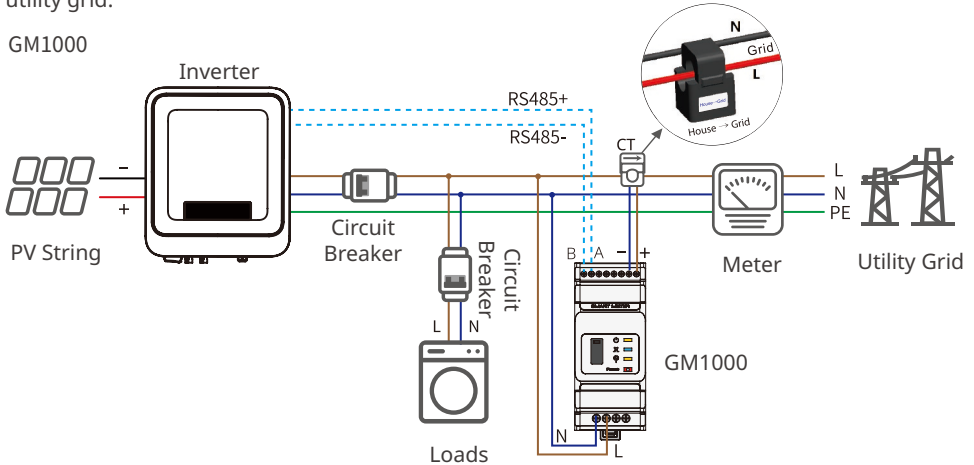

#### Notice

After completing cable connections, set related parameters via LCD or SolarGo app to enable export power limit control or output power limit control.

#### Load Monitoring Network

With the HomeKit device and two CTs, the inverter output data and on-grid data can be accurately measured to calculate the load electricity consumption. The operating data will be uploaded to the cloud via WiFi or LAN to realize 24 hours real-time load electricity consumption monitoring.

HK1000

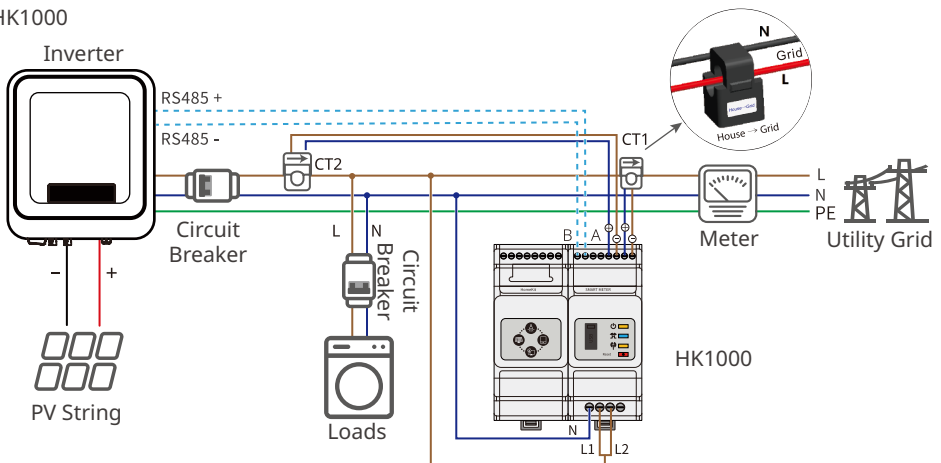

### 6.5.1 Connecting the Communication Cable (optional)

Communication Type	Terminal	Definition	Function
RS485	RS485	1: RS485+ 2: RS485-	Used to connect multi inverters or the RS485 port on the data logger.
Remote shutdown	RSD	3: RSD+ 4: RSD-	The port is reserved in compliance with grid regulations in Europe. Related devices should be prepared by customers.
Dry contact	I/O	5: I/O1+ 6: I/O1- 7: I/O2+ 8: I/O2- 9: I/O3+ 10: I/O3-	Reserved.
Meter	Meter	11: Meter + 12: Meter -	Realize the dynamic export limit function by connecting the meter and the CT. Contact the manufacturer to purchase the devices if you need them.
CT	CT	13: CT+ 14: CT-	
DRED	DRED	15: DRM1/5 16: DRM2/6 17: DRM3/7 18: DRM4/8 19: REFGEN 20: COM/DRM0	The port is reserved in compliance to grid regulations in Australia and New Zealand. Related devices should be prepared by customers.

The wiring method of communication terminals is as follows:

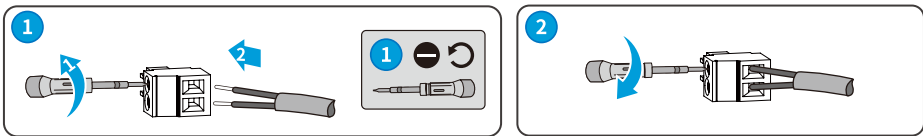

#### Notice

- Make sure that the communication device is connected to the right terminal. Route the communication cable far away from any interference source or power cable to prevent the signal from being influenced.
- Connect the RS485 cable, remote shutdown cable, meter cable, and CT cable using a 2PIN communication terminal.
- Connect the dry contact cable and DRED cable using a 6PIN communication terminal.
- Remove the short circuit wire and keep it properly when enabling the DRED function.

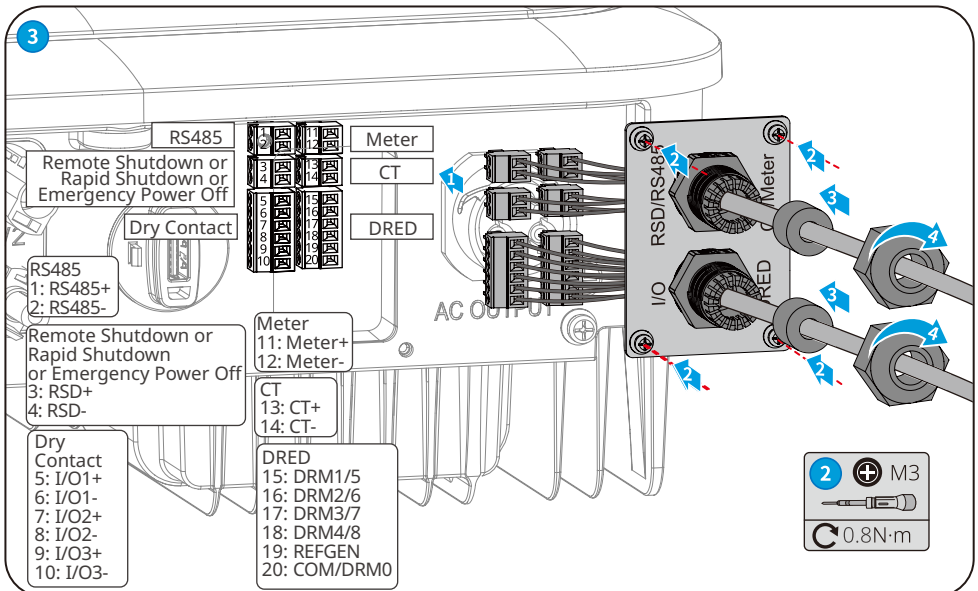
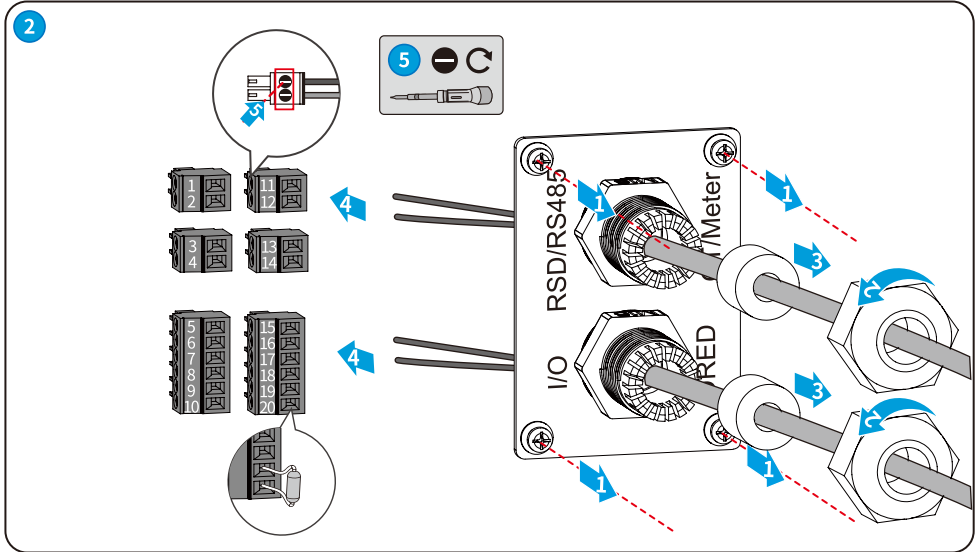
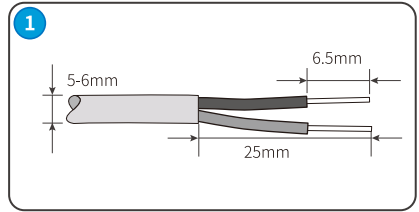
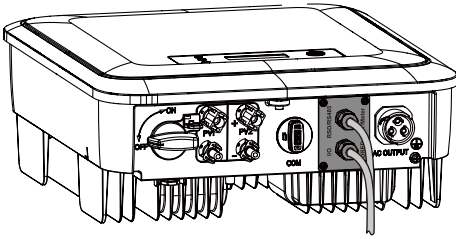

### 6.5.3 Installing the Communication Module (optional)

Plug a communication module into the inverter to establish a connection between the inverter and the smartphone or web pages. The communication module can be a Bluetooth module, WiFi module, LAN module, GPRS module, or 4G module. Set inverter parameters, check running information and fault information, and observe system status in time via the smartphone or web pages.

WiFi kit, LAN kit, 4G kit, GPRS, Bluetooth Kit, Wi-Fi/LAN Kit module: optional.

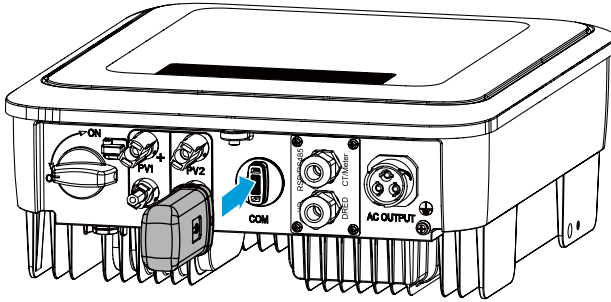

#### Notice

Refer to the delivered communication module user manual to get more introduction to the module. For more detailed information, visit <https://en.goodwe.com>.

### 6.5.4 Connecting the USB-RS485 Cable

USB-RS485 cable: Only for Brazil.

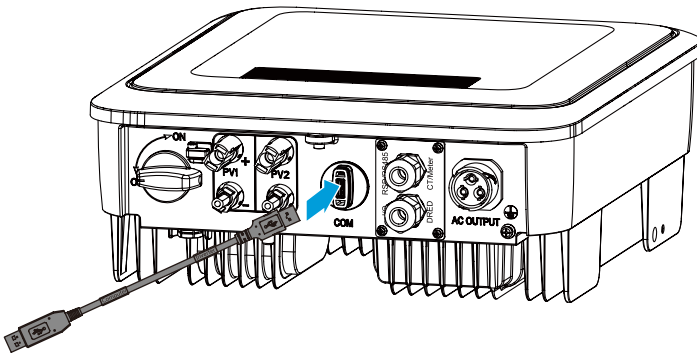

## 7 Equipment Commissioning

### 7.1 Check Before Power ON

No.	Check Item
1	The product is firmly installed at a clean place that is well-ventilated and easy to operate.
2	The PE, DC input, AC output, and communication cables are connected correctly and securely.
3	Cable ties are intact, routed properly and evenly.
4	Unused ports and terminals are sealed.
5	The voltage and frequency at the connection point meet the inverter grid connection requirements.

### 7.2 Power On

**Step 1** Turn on the AC switch between the inverter and the utility grid.

**Step 2** Turn on the DC switch of the inverter.

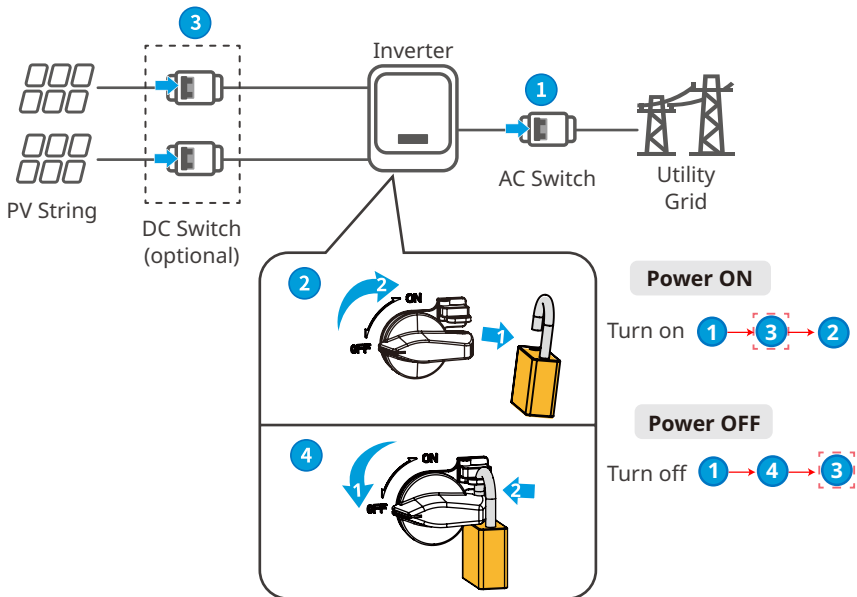













The DC switch lock is for Australia only.





















## 8 System Commissioning

### 8.1 Indicators and Buttons

With LCD

Indicator	Status	Description
 Power		ON = Wi-Fi IS CONNECTED/ACTIVE
		BLINK 1 = Wi-Fi SYSTEM IS RESETTING
		BLINK 2 = NOT CONNECTED TO THE ROUTER
		BLINK 4 = Wi-Fi SERVER PROBLEM
		BLINK = RS485 IS CONNECTED
		OFF = Wi-Fi IS NOT ACTIVE
 Operating		ON = THE INVERTER IS FEEDING POWER
		OFF = THE INVERTER IS NOT FEEDING POWER AT THE MOMENT
 Faulty		ON = A FAULT HAS OCCURRED
		OFF = NO FAULT

Without LCD

Indicators	Status	Description
 Power		ON= EQUIPMENT POWER ON
		OFF= EQUIPMENT POWER OFF
 Operating		ON= THE INVERTER IS FEEDING POWER
		OFF= THE INVERTER IS NOT FEEDING POWER
		SINGLE SLOW FLASH= SELF CHECK BEFORE CONNECTING TO THE GRID
		SINGLE FLASH = CONNECTING TO THE GRID
 SEMS		ON= WIRELESS IS CONNECTED/ACTIVE
		BLINK 1 = WIRELESS SYSTEM IS RESETTING
		BLINK 2 = WIRELESS ROUTER PROBLEM
		BLINK 4 = WIRELESS SERVER PROBLEM
		BLINK = RS485 IS CONNECTED
		OFF= WIRELESS IS NOT ACTIVE
 Faulty		ON= A FAULT HAS OCCURRED
		OFF= NO FAULT

## 8.2 Setting Inverter Parameters via LCD

NOTICE

- Inverter firmware version shown in this document is V1.00.00. Communication version: V1.00. The screenshots are for reference only. The actual interface may differ.
- The name, range, and default value of the parameters are subject to change or adjustment. The actual display prevails.
- To prevent the generating capacity from being influenced by wrong parameters, the power parameters should be set by professionals.

### LCD Button Description

- Stop pressing the button for a period on any page, the LCD will get dark and go back to the initial page.
- Short press the button to switch menu or adjust parameter values.
- Long press the button to enter the submenu. After adjusting the parameter values, long press to set it.

Examples:

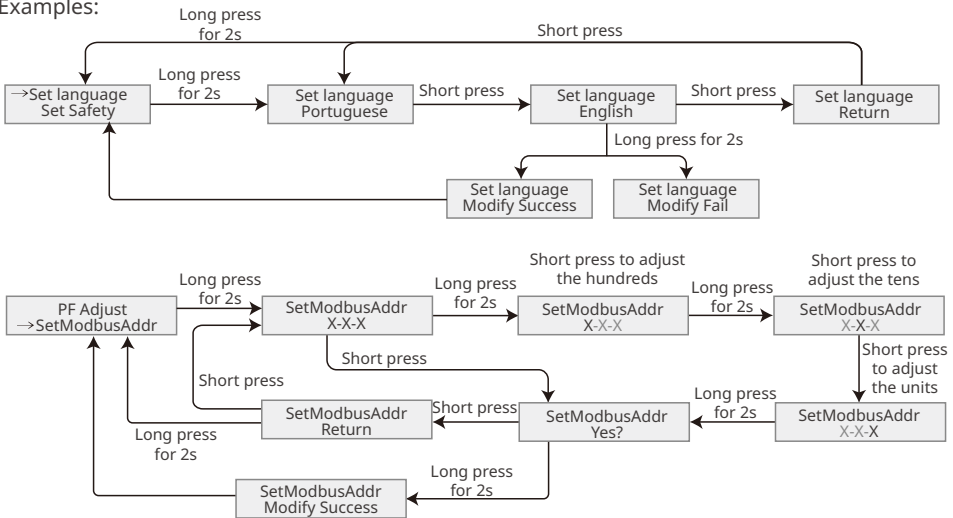

For Australia:

User need type the password to enter the sub-menu for parameter setting.

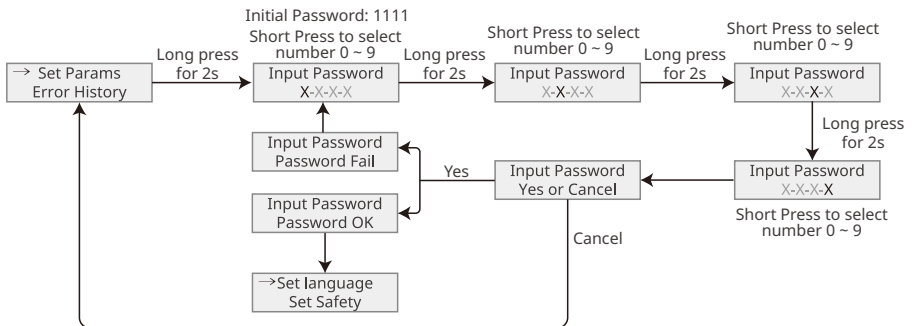

### 8.2.1 LCD Menu Introduction

This part describes the menu structure, allowing you to view inverter information and set parameters more conveniently.

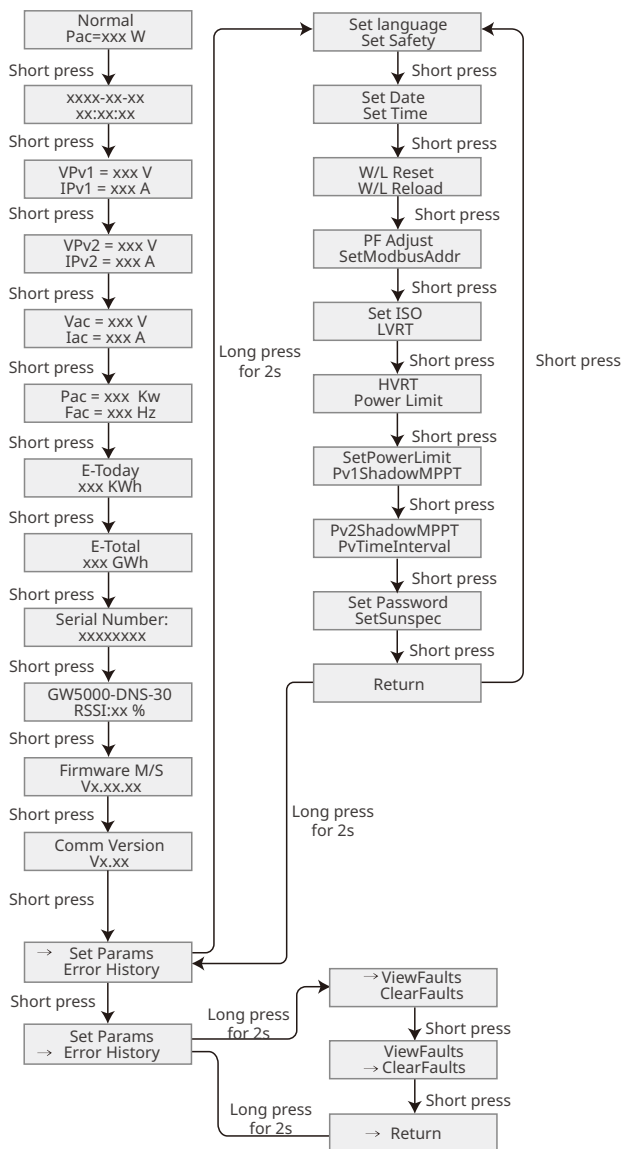

## 8.2.2 Inverter Parameter Introduction

Parameters	Description
Normal	Home page. Indicates the real-time power of the inverter.
2022-02-14 09:01:10	Check the time of the country/region.
VPv1	Check the DC input voltage of the inverter.
IPv1	Check the DC input current of the inverter.
Vac	Check the voltage of the utility grid.
Iac	Check the AC output current of the inverter.
Fac	Check the frequency of the utility grid.
E-Today	Check the generated power of the system for that day.
E-Total	Check the total generated power of the system.
Serial Number	Check the serial number of the inverter.
GW5000-DNS-30 RSSI	Check the signal strength of the communication module.
Firmware M/S	Check the firmware version.
Comm Version	Check the ARM software version.
Set Safety	Set the safety country/region in compliance with the local grid standards and application scenario of the inverter.
Set Date	Set time according to the actual time in the country/region where the inverter is located.
Set Time	
Set Password	The password can be changed. Keep the changed password in mind after changing it. Contact the after-sales service if you forget the password.
W/L Reset	Power off and restart the communication module.
W/L Reload	Restore the factory settings of the communication module. Reconfigure the communication module network parameters after restoring the factory settings,
PF Adjust	Set the power factor of the inverter according to the actual situation.
SetModbusAddr	Set the actual Modbus address.
Set ISO	Indicates the PV-PE insulation resistance threshold value. When the detected value is under the set value, the IOS fault occurs.

Parameters	Description
LVRT	With LVRT on, the inverter will stay connected with the utility grid after a short-term utility grid low voltage exception occurs.
HVRT	With HVRT on, the inverter will stay connected with the utility grid after a short-term utility grid high voltage exception occurs.
Power Limit	Set the power feed back into the utility grid according to the actual situation.
SetPowerLimit	
Pv1ShadowMPPT	Enable the shadow scan function if the PV panels are shadowed.
PV2ShadowMPPT	
PvTimeInterval	Set the scan time according to the actual needs.
SetSunspec	Set the Sunspeg based on the actual communication method.
ViewFaults	Check historical error message records of the inverter.
ClearFaults	Clear historical error message records of the inverter.

### 8.3 Upgrading the Firmware Via USB Flash Disk

**Step 1** Contact the after-sales service to obtain the upgrade package.

**Step 2** Save the upgrade package in the USB flash drive.

**Step 3** Insert the USB flash drive into the USB port, and upgrade the software version of the inverter following the prompts.

### 8.4 Setting Inverter Parameters via SolarGo App

SolarGo app is a mobile application that communicates with the inverter via Bluetooth module, WIFI module or GPRS module. Commonly used functions are as follows:

1. Check the operating data, software version, alarms, etc.
2. Set grid parameters, communication parameters, etc.
3. Equipment maintenance.

For more details, refer to the SolarGo APP User Manual. Scan the QR code or visit [https://en.goodwe.com/Ftp/EN/Downloads/User%20Manual/GW\\_SolarGo\\_User%20Manual-EN.pdf](https://en.goodwe.com/Ftp/EN/Downloads/User%20Manual/GW_SolarGo_User%20Manual-EN.pdf) to get the user manual.



SolarGo App



SolarGo App User Manual

## 9 Maintenance

### 9.1 Power Off the Inverter

#### DANGER

- Power off the inverter before operations and maintenance. Otherwise, the inverter may be damaged or electric shocks may occur.
- Delayed discharge. Wait until the components are discharged after power off.

**Step 1** (optional) Send shutdown command to the inverter.

**Step 2** Turn off the AC switch between the inverter and the utility grid.

**Step 3** Turn off the DC switch of the inverter.

### 9.2 Removing the Inverter

#### WARNING

- Make sure that the inverter is powered off.
- Wear proper PPE before any operations.

**Step 1** Disconnect all the cables, including DC cables, AC cables, communication cables, the communication module, and PE cables.

**Step 2** Grab the handles or hoist the inverter to remove the inverter from the mounting plate.

**Step 3** Remove the mounting plate.

**Step 4** Store the inverter properly. If the inverter needs to be used later, ensure that the storage conditions meet the requirements.

### 9.3 Disposing of the Inverter

If the inverter cannot work anymore, dispose of it according to the local disposal requirements for electrical equipment waste. The inverter cannot be disposed of together with household waste.

### 9.4 Troubleshooting

Perform troubleshooting according to the following methods. Contact the after-sales service if these methods do not work.

Collect the information below before contacting the after-sales service, so that the problems can be solved quickly.

1. Inverter information like serial number, software version, installation date, fault time, fault frequency, etc.
2. Installation environment, including weather conditions, whether the PV modules are sheltered or shadowed, etc. It is recommended to provide some photos and videos to assist in analyzing the problem.
3. Utility grid situation.

No.	Fault	Cause	Solutions
1	Utility Loss	1. Utility grid power fails. 2. The AC cable is disconnected, or the AC breaker is off.	1. The alarm is automatically cleared after the grid power supply is restored. 2. Check whether the AC cable is connected and the AC breaker is on.
2	Grid Overvoltage	The grid voltage exceeds the permissible range, or the duration of high voltage exceeds the requirement of HVRT.	1. If the problem occurs occasionally, the utility grid may be abnormal temporarily. The inverter will recover automatically after detecting that the utility grid is normal. 2. If the problem occurs frequently, check whether the grid voltage is within the permissible range. <ul style="list-style-type: none"> <li>• Contact the local power company if the grid voltage exceeds the permissible range.</li> <li>• Modify the overvoltage protection threshold, HVRT or disable the overvoltage protection function after obtaining the consent of the local power company if the grid frequency is within the permissible range.</li> </ul> 3. Check whether the AC breaker and the output cables are connected securely and correctly if the problem persists.
3	Grid Rapid Overvoltage	The grid voltage is abnormal or ultra-high.	1. If the problem occurs occasionally, the utility grid may be abnormal temporarily. The inverter will recover automatically after detecting that the utility grid is normal. 2. If the problem occurs frequently, check whether the grid voltage is within the allowed range. <ul style="list-style-type: none"> <li>• Contact the local power company if the grid voltage exceeds the permissible range.</li> <li>• Modify the grid overvoltage rapid protection threshold after obtaining the consent of the local power company if the grid voltage is within the permissible range.</li> </ul>

No.	Fault	Cause	Solutions
4	Grid Undervoltage	The grid voltage is lower than the permissible range, or the duration of low voltage exceeds the requirement of LVRT.	<ol style="list-style-type: none"> <li>1. If the problem occurs occasionally, the utility grid may be abnormal temporarily. The inverter will recover automatically after detecting that the utility grid is normal.</li> <li>2. If the problem occurs frequently, check whether the grid voltage is within the permissible range.                             <ul style="list-style-type: none"> <li>• Contact the local power company if the grid voltage exceeds the permissible range.</li> <li>• Modify the undervoltage protection threshold, LVRT or disable the undervoltage protection function after obtaining the consent of the local power company if the grid frequency is within the permissible range.</li> </ul> </li> <li>3. Check whether the AC breaker and the output cables are connected securely and correctly if the problem persists.</li> </ol>
5	Grid 10min Overvoltage	The moving average of grid voltage in 10min exceeds the range of safety requirements.	<ol style="list-style-type: none"> <li>1. If the problem occurs occasionally, the utility grid may be abnormal temporarily. The inverter will recover automatically after detecting that the utility grid is normal.</li> <li>2. If the problem occurs frequently, check whether the grid voltage is within the permissible range.                             <ul style="list-style-type: none"> <li>• Contact the local power company if the grid voltage exceeds the permissible range.</li> <li>• Modify the 10min overvoltage protection threshold with the consent of the local power company if the grid voltage is within the permissible range.</li> </ul> </li> </ol>
6	Grid Overfrequency	Utility grid exception. The actual grid frequency exceeds the requirement of the local grid standard.	<ol style="list-style-type: none"> <li>1. If the problem occurs occasionally, the utility grid may be abnormal temporarily. The inverter will recover automatically after detecting that the utility grid is normal.</li> <li>2. If the problem occurs frequently, check whether the grid frequency is within the permissible range.                             <ul style="list-style-type: none"> <li>• Contact the local power company if the grid frequency exceeds the permissible range.</li> <li>• Modify the overfrequency protection threshold or disable the overfrequency protection function after obtaining the consent of the local power company if the grid frequency is within the permissible range.</li> </ul> </li> </ol>



No.	Fault	Cause	Solutions
7	Grid Underfrequency	Utility grid exception. The actual grid frequency is lower than the requirement of the local grid standard.	<ol style="list-style-type: none"> <li>If the problem occurs occasionally, the utility grid may be abnormal temporarily. The inverter will recover automatically after detecting that the utility grid is normal.</li> <li>If the problem occurs frequently, check whether the grid frequency is within the permissible range. <ul style="list-style-type: none"> <li>Contact the local power company if the grid frequency exceeds the permissible range.</li> <li>Modify the underfrequency protection threshold or disable the underfrequency protection function after obtaining the consent of the local power company if the grid frequency is within the permissible range.</li> </ul> </li> </ol>
8	Grid Frequency Instability	Utility grid exception. The actual grid frequency change rate does not meet the requirement of the local grid standard.	<ol style="list-style-type: none"> <li>If the problem occurs occasionally, the utility grid may be abnormal temporarily. The inverter will recover automatically after detecting that the utility grid is normal.</li> <li>If the problem occurs frequently, check whether the grid frequency is within the permissible range. <ul style="list-style-type: none"> <li>Contact the local power company if the grid frequency exceeds the permissible range.</li> <li>Contact the dealer or the after-sales service if the grid frequency is within the permissible range.</li> </ul> </li> </ol>
9	Anti-islanding	The utility grid is disconnected. The utility grid is disconnected according to the safety regulations, but the grid voltage is maintained due to the loads.	<ol style="list-style-type: none"> <li>Check whether the utility grid is disconnected.</li> <li>Contact the dealer or the after-sales service.</li> </ol>
10	LVRT Undervoltage	Utility grid exception. The duration of the utility grid exception exceeds the set time of LVRT.	<ol style="list-style-type: none"> <li>If the problem occurs occasionally, the utility grid may be abnormal temporarily. The inverter will recover automatically after detecting that the utility grid is normal.</li> <li>If the problem occurs frequently, check whether the grid frequency is within the permissible range. If not, contact the local power company. If yes, contact the dealer or the after-sales service.</li> </ol>
11	HVRT Overvoltage	Utility grid exception. The duration of utility grid exception exceeds the set time of HVRT.	<ol style="list-style-type: none"> <li>If the problem occurs occasionally, the utility grid may be abnormal temporarily. The inverter will recover automatically after detecting that the utility grid is normal.</li> <li>If the problem occurs frequently, check whether the grid frequency is within the permissible range. If not, contact the local power company. If yes, contact the dealer or the after-sales service.</li> </ol>

No.	Fault	Cause	Solutions
12	Abnormal GFCI 30mA	The input insulation impedance becomes low when the inverter is working.	<ol style="list-style-type: none"> <li>1. If the problem occurs occasionally, it may be caused by a cable exception. The inverter will recover automatically after the problem is solved.</li> <li>2. Check whether the impedance between the PV string and PE is too low if the problem occurs frequently or persists.</li> </ol>
13	Abnormal GFCI 60mA		
14	Abnormal GFCI 150mA		
15	Abnormal GFCI		
16	Large DC of AC current L1	The DC component of the output current exceeds the safety range or default range.	<ol style="list-style-type: none"> <li>1. If the problem is caused by an external fault like a utility grid exception or frequency exception, the inverter will recover automatically after solving the problem.</li> <li>2. If the problem occurs frequently and the PV station cannot work properly, contact the dealer or the after-sales service.</li> </ol>
17	Large DC of AC current L2		
18	Low Insulation Res. (Earth fault alarm)	<ol style="list-style-type: none"> <li>1. The PV string is short-circuited to PE.</li> <li>2. The PV system is in a moist environment and the cable is not well insulated to the ground.</li> </ol>	<ol style="list-style-type: none"> <li>1. Check whether the resistance of the PV string to PE exceeds 50kΩ. If no, check the short circuit point.</li> <li>2. Check whether the PE cable is connected correctly.</li> <li>3. If the resistance is lower on rainy days, please reset the ISO.</li> </ol> <p>Inverters for the Australian and New Zealand markets can also be alerted in the following ways in the event of insulation impedance failure:</p> <ol style="list-style-type: none"> <li>1. The inverter is equipped with the buzzer: the buzzer sounds continuously for 1 minute in case of failure; If the fault is not resolved, the buzzer sounds every 30 minutes.</li> <li>2. Add the inverter to the monitoring platform, and set the alarm reminder, the alarm information can be sent to the customer by emails.</li> </ol>
19	Abnormal Ground	<ol style="list-style-type: none"> <li>1. The PE cable of the inverter is not connected well.</li> <li>2. The L cable and N cable are connected reversely when output of the PV string is grounded.</li> </ol>	<ol style="list-style-type: none"> <li>1. Check whether the PE cable of the inverter is connected properly.</li> <li>2. Check whether the L cable and N cable are connected reversely if output of the PV string is grounded.</li> </ol>

No.	Fault	Cause	Solutions
20	Anti Reverse power Failure	Abnormal fluctuation of load	<ol style="list-style-type: none"> <li>1. If the exception is caused by an external fault, the inverter will recover automatically after solving the problem.</li> <li>2. If the problem occurs frequently and the PV station cannot work properly, contact the dealer or the after-sales service.</li> </ol>
21	Internal Comm Loss	<ol style="list-style-type: none"> <li>1. Frame format error</li> <li>2. Parity checking error</li> <li>3. Can bus offline</li> <li>4. Hardware CRC error</li> <li>5. Send (receive) control bit is receive (send).</li> <li>6. Transmit to the unit that is not allowed.</li> </ol>	Disconnect the AC output switch and DC input switch, then connect them 5 minutes later. Contact the dealer or the after-sales service if the problem persists.
22	AC HCT Check abnormal	The sampling of the AC HCT is abnormal.	Disconnect the AC output switch and DC input switch, then connect them 5 minutes later. Contact the dealer or the after-sales service if the problem persists.
23	GFCI HCT Check abnormal	The sampling of the GFCI HCT is abnormal.	Disconnect the AC output switch and DC input switch, then connect them 5 minutes later. Contact the dealer or the after-sales service if the problem persists.
24	Relay Check abnormal	<ol style="list-style-type: none"> <li>1. The relay is abnormal or short-circuited.</li> <li>2. The control circuit is abnormal.</li> <li>3. The AC cable connection is abnormal, like a virtual connection or short circuit.</li> </ol>	Disconnect the AC output switch and DC input switch, then connect them 5 minutes later. Contact the dealer or the after-sales service if the problem persists.
25	Internal Fan abnormal	<ol style="list-style-type: none"> <li>1. The fan power supply is abnormal.</li> <li>2. Mechanical exception.</li> <li>3. The fan is aging and damaged.</li> </ol>	Disconnect the AC output switch and DC input switch, then connect them 5 minutes later. Contact the dealer or the after-sales service if the problem persists.
26	Flash Fault	The internal Flash storage is abnormal.	Disconnect the AC output switch and DC input switch, then connect them 5 minutes later. Contact the dealer or the after-sales service if the problem persists.

No.	Fault	Cause	Solutions
27	DC Arc Fault	<ol style="list-style-type: none"> <li>1. The DC terminal is not firmly connected.</li> <li>2. The DC cable is broken.</li> </ol>	Read the Quick Installation Guide and check whether the cables are connected properly.
28	AFCI Self-test Fault	AFCI detection is abnormal.	Disconnect the AC output switch and DC input switch, then connect them 5 minutes later. Contact the dealer or the after-sales service if the problem persists.
29	Cavity Overtemperature	<ol style="list-style-type: none"> <li>1. The inverter is installed in a place with poor ventilation.</li> <li>2. The ambient temperature exceeds 60°C.</li> <li>3. A fault occurs in the internal fan of the inverter.</li> </ol>	<ol style="list-style-type: none"> <li>1. Check the ventilation and the ambient temperature at the installation point.</li> <li>2. If the ventilation is poor or the ambient temperature is too high, improve the ventilation and heat dissipation.</li> <li>3. Contact the dealer or after-sales service if both the ventilation and the ambient temperature are normal.</li> </ol>
30	BUS Overvoltage	<ol style="list-style-type: none"> <li>1. The PV voltage is too high.</li> <li>2. The sampling of the inverter BUS voltage is abnormal.</li> </ol>	Disconnect the AC output switch and DC input switch, then connect them 5 minutes later. Contact the dealer or the after-sales service if the problem persists.
31	PV Input Overvoltage	The PV array configuration is not correct. Too many PV panels are connected in series in the PV string.	Check the serial connection of the PV array. Make sure that the open circuit voltage of the PV string is not higher than the maximum operating voltage of the inverter.
32	PV Continuous Hardware Overcurrent	<ol style="list-style-type: none"> <li>1. The PV configuration is not proper.</li> <li>2. The hardware is damaged.</li> </ol>	Disconnect the AC output switch and DC input switch, then connect them 5 minutes later. Contact the dealer or the after-sales service if the problem persists.
33	PV Continuous Software Overcurrent	<ol style="list-style-type: none"> <li>1. The PV configuration is not proper.</li> <li>2. The hardware is damaged.</li> </ol>	Disconnect the AC output switch and DC input switch, then connect them 5 minutes later. Contact the dealer or the after-sales service if the problem persists.
34	String1 PV String Reversed	The PV string is connected reversely.	Check whether the PV1 and PV2 strings are connected reversely.
35	String2 PV String Reversed		

## 9.5 Routine Maintenance

Maintaining Item	Maintaining Method	Maintaining Period
System Clean	Check the heat sink, air intake, and air outlet for foreign matter or dust.	Once 6-12 months
DC Switch	Turn the DC switch on and off ten consecutive times to make sure that it is working properly.	Once a year
Electrical Connection	Check whether the cables are securely connected. Check whether the cables are broken or whether there is any exposed copper core.	Once 6-12 months
Sealing	Check whether all the terminals and ports are properly sealed. Reseal the cable hole if it is not sealed or too big.	Once a year

## 10 Technical Parameters

Technical Parameters	GW3000-DNS-30	GW3600-DNS-30	GW4200-DNS-30	GW5000-DNS-30
<b>Input</b>				
Max.Input Power (W)	4,500	5,400	6,300	7,500
Max.Input Voltage (V)	600	600	600	600
MPPT Operating Voltage Range (V)	40~560	40~560	40~560	40~560
MPPT Voltage Range at Nominal Power (V)	100~500	120~500	140~500	165~500
Start-up Voltage (V)	50	50	50	50
Nominal Input Voltage (V)	360	360	360	360
Max. Input Current per MPPT (A)	16	16	16	16
Max. Short Circuit Current per MPPT (A)	23	23	23	23
Max.Backfeed Current to The Array (A)	0	0	0	0
Number of MPP trackers	2	2	2	2
Number of Strings per MPPT	1	1	1	1
<b>Output</b>				
Nominal Output Power (W)	3,000	3,600	4200*1	5,000
Nominal Output Apparent Power (VA)	3,000	3,600	4200*1	5,000
Max. AC Active Power (W)*5	3,300	3,960*2	4620*1*2	5500
Max. AC Apparent Power (VA)*5	3,300	3,960*2	4620*1*2	5500
Nominal Power at 40°C(W)(Only for Brazil)	3,000	3,600	4,200	5,000
Max Power at 40°C (Including AC Overload)(W)(Only for Brazil)	3,000	3,600	4,200	5,000

Technical Parameters	GW3000-DNS-30	GW3600-DNS-30	GW4200-DNS-30	GW5000-DNS-30
Nominal Output Voltage (V)	220/230/240	220/230/240	220/230/240	220/230/240
Output Voltage Range (V)	196~311 (According to local standard)			
Nominal AC Grid Frequency (Hz)	50/60	50/60	50/60	50/60
AC Grid Frequency Range (Hz)	45~55 / 55~65	45~55 / 55~65	45~55 / 55~65	45~55 / 55~65
Max. Output Current (A)	14.4	17.3*2	20.1*2	24.0
Max. Output Fault Current (Peak and Duration) (A) (at 4ms)	33.4	33.4	44.5	44.5
Inrush Current (Peak and Duration) (A) (at 10μs)	39	39	39	39
Nominal Output Current (A)	13.7	16.4	19.1	22.8
Power Factor	~1 (Adjustable from 0.8 leading to 0.8 lagging)			
Max. Total Harmonic Distortion	<3%			
Maximum Output Overcurrent Protection (A)	31	31	42	42
<b>Efficiency</b>				
Max. Efficiency	97.9%	97.9%	97.9%	97.9%
European Efficiency	97.0%	97.0%	97.2%	97.3%
CEC Efficiency	97.2%	97.2%	97.3%	97.3%
<b>Protection</b>				
PV String Current Monitoring	Integrated			
PV Insulation Resistance Detection	Integrated			
Residual Current Monitoring	Integrated			
PV Reverse Polarity Protection	Integrated			
Anti-islanding Protection	Integrated			

Technical Parameters	GW3000-DNS-30	GW3600-DNS-30	GW4200-DNS-30	GW5000-DNS-30
AC Overcurrent Protection	Integrated			
AC Short Circuit Protection	Integrated			
AC Overvoltage Protection	Integrated			
DC Switch	Integrated			
DC Surge Protection	Type III(Type II Optional)			
AC Surge Protection	Type III(Type II Optional)			
AFCI	Optional			
Emergency Power Off	Optional			
Remote Shutdown	Optional			
Power Supply at Night	Optional			
<b>General Data</b>				
Operating Temperature Range (°C)	-25~+60			
Relative Humidity	0~100%			
Max. Operating Altitude (m)*3	4000			
Cooling Method	Natural Convection			
User Interface	LED, LCD (Optional), WLAN+APP			
Communication	WiFi,RS485 or LAN or 4G or DI(Ripple Control or DRM)(Optional)			
Communication Protocols	Modbus-RTU (SunSpec Compliant)			
Weight (kg)	12.8			
Dimension W×H×D (mm)	350×410×143			
Noise Emission (dB)	<25			
Topology	Non-isolated			
Self-consumption at Night (W)	<1			
Ingress Protection Rating	IP66			
Anti-corrosion Class	C4			
DC Connector	MC4 (4~6mm <sup>2</sup> )			



Technical Parameters	GW3000-DNS-30	GW3600-DNS-30	GW4200-DNS-30	GW5000-DNS-30
AC Connector	Plug and play connector (Max.6 mm <sup>2</sup> )			
Environmental Category	4K4H			
Pollution Degree	III			
Overvoltage Category	DC II / AC III			
Protective Class	I			
The Decisive Voltage Class (DVC)	PV: C AC: C Com: A			
Active Anti-islanding Method	AFDPF + AQDPF *4			
Country of Manufacture(Only for Australia)	China			

Technical Parameters	GW6000-DNS-30	GW5000-DNS-B30	GW6000-DNS-B30
<b>Input</b>			
Max.Input Power (W)	9,000	7,500	9,000
Max.Input Voltage (V)	600	600	600
MPPT Operating Voltage Range (V)	40~560	40~560	40~560
MPPT Voltage Range at Nominal Power (V)	195~500	165~500	195~500
Start-up Voltage (V)	50	50	50
Nominal Input Voltage (V)	360	360	360
Max. Input Current per MPPT (A)	16	16	16
Max. Short Circuit Current per MPPT (A)	23	23	23
Max.Backfeed Current to The Array (A)	0	0	0
Number of MPP trackers	2	2	2
Number of Strings per MPPT	1	1	1

Technical Parameters	GW6000-DNS-30	GW5000-DNS-B30	GW6000-DNS-B30
<b>Output</b>			
Nominal Output Power (W)	6,000	5,000	6,000
Nominal Output Apparent Power (VA)	6,000	5,000	6,000
Max. AC Active Power (W) <sup>*5</sup>	6,600	5,500	6,600
Max. AC Apparent Power (VA) <sup>*5</sup>	6,600	5,500	6,600
Nominal Power at 40°C(W) (Only for Brazil)	6,000	5,000	6,000
Max Power at 40°C (Including AC Overload)(W)(Only for Brazil)	6,000	5,000	6,000
Nominal Output Voltage (V)	220/230/240	220/230/240	220/230/240
Output Voltage Range (V)	196~311 (According to local standard)		
Nominal AC Grid Frequency (Hz)	50/60	50/60	50/60
AC Grid Frequency Range (Hz)	45~55 / 55~65	45~55 / 55~65	45~55 / 55~65
Max. Output Current (A)	28.8	24.0	28.8
Max. Output Fault Current (Peak and Duration) (A) (at 4ms)	55.8	44.5	55.8
Inrush Current (Peak and Duration) (A) (at 10μs)	39	39	39
Nominal Output Current (A)	27.3	22.8	27.3
Power Factor	~1 (Adjustable from 0.8 leading to 0.8 lagging)		
Max. Total Harmonic Distortion	<3%		
Maximum Output Overcurrent Protection (A)	52	42	52
<b>Efficiency</b>			
Max. Efficiency	97.9%	97.9%	97.9%
European Efficiency	97.4%	97.3%	97.4%
CEC Efficiency	97.4%	97.3%	97.4%
<b>Protection</b>			
PV String Current Monitoring	Integrated		
PV Insulation Resistance Detection	Integrated		
Residual Current Monitoring	Integrated		

Technical Parameters	GW6000-DNS-30	GW5000-DNS-B30	GW6000-DNS-B30
PV Reverse Polarity Protection	Integrated		
Anti-islanding Protection	Integrated		
AC Overcurrent Protection	Integrated		
AC Short Circuit Protection	Integrated		
AC Overvoltage Protection	Integrated		
DC Switch	Integrated		
DC Surge Protection	Type III(Type II Optional)	Type III	Type III
AC Surge Protection	Type III(Type II Optional)	Type III	Type III
AFCI	Optional		
Emergency Power Off	Optional	NA	NA
Remote Shutdown	Optional		
Power Supply at Night	Optional		
<b>General Data</b>			
Operating Temperature Range (°C)	-25~+60		
Relative Humidity	0~100%		
Max. Operating Altitude (m) <sup>*3</sup>	4000		
Cooling Method	Natural Convection		
User Interface	LED, LCD (Optional), WLAN+APP		
Communication	WiFi,RS485 or LAN or 4G or DI(Ripple Control or DRM)(Optional)		
Communication Protocols	Modbus-RTU (SunSpec Compliant)		
Weight (kg)	13.4	12.8	13.4
Dimension W×H×D (mm)	350×410×143		
Noise Emission (dB)	<25		
Topology	Non-isolated		
Self-consumption at Night (W)	<1		
Ingress Protection Rating	IP66		
Anti-corrosion Class	C4		
DC Connector	MC4 (4~6mm <sup>2</sup> )		
AC Connector	Plug and play connector (Max.6 mm <sup>2</sup> )		
Environmental Category	4K4H		
Pollution Degree	III		
Overvoltage Category	DC II / AC III		

Technical Parameters	GW6000-DNS-30	GW5000-DNS-B30	GW6000-DNS-B30
Protective Class	I		
The Decisive Voltage Class (DVC)	PV: C AC: C Com: A		
Active Anti-islanding Method	AFDPF + AQDPF *4		
Country of Manufacture(Only for Australia)	China		

Technical Parameters	GW5000-DNS-EU30
<b>Input</b>	
Max. Input Power (W)*6	7,500
Max. Input Voltage (V)	600
MPPT Operating Voltage Range (V)	40 - 560
MPPT Voltage Range at Nominal Power (V)	165 - 500
Start-up Voltage (V)	50
Nominal Input Voltage (V)	360
Max. Input Current per MPPT (A)	16
Max. Short Circuit Current per MPPT (A)	23
Max. Backfeed Current to The Array (A)	0
Number of MPP Trackers	2
Number of Strings per MPPT	1
<b>Output</b>	
Nominal Output Power (W)	5,000
Nominal Output Apparent Power (VA)	5,000
Max. AC Active Power (W)*5	5,000
Max. AC Apparent Power (VA)*5	5,000
Nominal Output Voltage (V)	220/230/240
Output Voltage Range (V)	196~311 (According to local standard)
Nominal AC Grid Frequency (Hz)	50/60
AC Grid Frequency Range (Hz)	45~55 / 55~65
Max. Output Current (A)	22.8
Max. Output Fault Current (Peak and Duration) (A) (at 4ms)	44.5
Inrush Current (Peak and Duration) (A) (at 10μs)	39
Nominal Output Current (A)	22.8

Technical Parameters	GW5000-DNS-EU30
Power Factor	~1 (Adjustable from 0.8 leading to 0.8 lagging)
Max. Total Harmonic Distortion	<3%
Maximum Output Overcurrent Protection (A)	42
<b>Efficiency</b>	
Max. Efficiency	97.9%
European Efficiency	97.3%
CEC Efficiency	97.3%
<b>Protection</b>	
PV String Current Monitoring	Integrated
PV Insulation Resistance Detection	Integrated
Residual Current Monitoring	Integrated
PV Reverse Polarity Protection	Integrated
Anti-islanding Protection	Integrated
AC Overcurrent Protection	Integrated
AC Short Circuit Protection	Integrated
AC Overvoltage Protection	Integrated
DC Switch	Integrated
DC Surge Protection	Type III(Type II Optional)
AC Surge Protection	Type III(Type II Optional)
AFCI	Optional
Emergency Power Off	Optional
Remote Shutdown	Optional
Power Supply at Night	Optional
<b>General Data</b>	
Operating Temperature Range (°C)	-25~+60
Relative Humidity	0~100%
Max. Operating Altitude (m)*3	4000
Cooling Method	Natural Convection
User Interface	LED, LCD (Optional), WLAN+APP
Communication	WiFi,RS485 or LAN or 4G or DI(Ripple Control or DRM)(Optional)
Communication Protocols	Modbus-RTU (SunSpec Compliant)
Weight (kg)	12.8
Dimension W×H×D (mm)	350×410×143
Noise Emission (dB)	<25

Technical Parameters	GW5000-DNS-EU30
Topology	Non-isolated
Self-consumption at Night (W)	<1
Ingress Protection Rating	IP66
Anti-corrosion Class	C4
DC Connector	MC4 (4~6mm <sup>2</sup> )
AC Connector	Plug and play connector (Max.6 mm <sup>2</sup> )
Environmental Category	4K4H
Pollution Degree	III
Overvoltage Category	DC II / AC III
Protective Class	I
The Decisive Voltage Class (DVC)	PV: C AC: C Com: A
Active Anti-islanding Method	AFDPF + AQDPF *4
Country of Manufacture(Only for Australia)	China

\*1. For Malaysia GW4200-DNS-30 Nominal Output Power (W) and Nominal Output Apparent Power (VA) and Max. AC Active Power (W) and Max. AC Apparent Power (VA) is 4000

\*2. For Netherland Max. AC Active Power (W) and Max. AC Apparent Power (VA) GW3600-DNS-30 is 3600, GW4200-DNS-30 is 4200; Max. Output Current (A) and Nominal Output Current (A) GW3600-DNS-30 is 15.7, GW4200-DNS-30 is 18.3.

\*3. For Australia Max. Operating Altitude (m) GW3000-DNS-30, GW3600-DNS-30, GW4200-DNS-30, GW5000-DNS-30, GW6000-DNS-30 is 3000.

\*4. AFDPF: Active Frequency Drift with Positive Feedback, AQDPF: Active Q Drift with Positive Feedback.

\*5:For Chile Max. AC Active Power (W) & Max.Output Apparent Power(VA) GW3000-DNS-30 is 3000, GW3600-DNS-30 is 3600, GW4200-DNS-30 is 4200, GW5000-DNS-30 is 5000, GW6000-DNS-30 is 6000.

\*6:For Brazil Max. Input Power (W), GW3000-DNS-30 is 5400, GW3600-DNS-30 is 6480, GW4200-DNS-30 is 7560, GW5000-DNS-30 is 9000, GW6000-DNS-30 is 10800, GW5000-DNS-B30 is 9000, GW6000-DNS-B30 is 10800.



Official Website

**GoodWe Technologies Co.,Ltd.**

---

 No. 90 Zijin Rd., New District, Suzhou, 215011, China

 [www.goodwe.com](http://www.goodwe.com)

 [service@goodwe.com](mailto:service@goodwe.com)



Contact Information